

Shelly[®] 4^{PRO}

4 Circuit WiFi Relay Switch

USER GUIDE
WARRANTY & WARRANTY TERMS



Allterco Robotics EOOD
Sofia, Bulgaria © January, 2019

USER GUIDE

WiFi Quad Relay Switch Shelly®

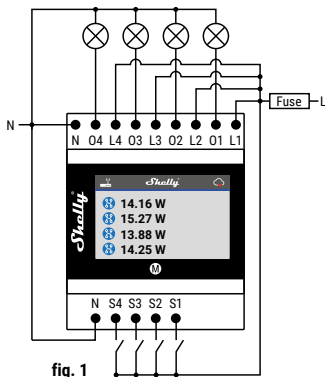

LEGEND:

- N - Neutral input (Zero);
- L - Line input (110-230V);
- L1, 2, 3, 4* - Input of O1, 2, 3, 4;
- O1, 2, 3, 4 - Output 1, 2, 3, 4;
- S - Switch (input) for control;
- S1, 2, 3, 4 - Switch (input) controlling O1, 2, 3, 4

*The cables connected to L1, L2, L3 and L4 must be with the same length!

The Shelly® WiFi Quad smart relay by Allterco Robotics is intended to be mounted into a standard switchboard, next to the circuit breakers in order to control and monitor the electric power through it. Shelly can work as a standalone Device or as an accessory to a home automation controller.

Specification

Power supply:

110-230V $\pm 10\%$ 50/60Hz AC

Max load per channel:

10A / 230V, 50/60Hz

Complies with EU standards:

- RE Directive 2014/53/EU
- LVD 2014/35/EU
- EMC 2004/108/WE
- RoHS2 2011/65/UE

Working temperature:

0 - 40°C

Radio signal power:

1mW

Radio protocol:

WiFi 802.11 b/g/n

Frequency:

2400 - 2500 MHz;

Operational range (depending on local construction):

- up to 50 m outdoors
- up to 30 m indoors

Dimensions (HxWxL):

90 x 52 x 57 mm

Electrical consumption:

< 1 W

Display

Home Screen – Shows the status of the circuit (on/off) and current power consumption.

fig. 2



WiFi Settings – Shows: Mode, Status, SSID (name of the network), IP and MAC address. On this screen (fig.2), holding the button can reset Shelly to Access Point (AP) mode.

WARNING! Even if the Device is in AP mode and you have set your password, it will be removed after resetting.

fig. 3



Device Info – Shows: Firmware and hardware versions, model and name of the Device, connection to the Cloud, time. On this screen (fig.3), by holding the button can return Shelly to factory settings.

WARNING! When returning the Device to factory settings, it will be in AP mode without username and password. To prevent unauthorized access to the Device and connected appliances (circuits), please connect Shelly to an existing WiFi network or set your own password.

Status bar – It is available on all screens, positioned at the top of the display. You can see icons showing: Mode, Time Synchronization and connection to the Cloud service.

Status Bar Legend:



– Access Point (AP) mode



– Client mode (CM), missing Internet connection



– Client mode (CM), available Internet connection



– Missing Cloud connection



– Available Cloud connection



– Synchronized Time



– Turned off appliance (circuit)



– Turned on appliance (circuit)

Technical Information

- Control through WiFi from a mobile phone, PC, automation system or any other Device supporting HTTP and/or UDP protocol.
- Microprocessor management.
- Controlled elements: 4 electrical circuits/appliances.
- Controlling elements: 4 relays.
- Shelly may be controlled by an external button/switch.



CAUTION! Danger of electrocution. Plugging the Device to the power grid has to be performed with caution.



CAUTION! Do not allow children to play with the button/switch connected the Device. Keep the remote control Devices of Shelly (mobile phones, tablets, PCs) away from children.

Introduction to Shelly®

Shelly® is a family of innovative Devices, which allows remote control of electric appliances through mobile phone, PC or home automation system. Shelly® uses WiFi to connect to the Devices controlling it. They can be in the same WiFi network or they can use remote access (through the Internet). Shelly® may work standalone, without being managed by a home automation controller, in the local WiFi network, as well as through a cloud service, from everywhere the User has an Internet access.

Shelly® has an integrated web server, through which the User may adjust, control and monitor the Device. Shelly® has two WiFi modes - access Point (AP) and Client mode (CM). To operate in Client Mode, a WiFi router must be located within the

range of the Device. Shelly® Devices can communicate directly with other WiFi Devices through HTTP protocol.

An API can be provided by the Manufacturer. Shelly® Devices may be available for monitor and control even if the User is outside the range of the local WiFi network, as long as the WiFi router is connected to the Internet. The Cloud function could be used, if it is activated through the web server of the Device or through the settings in the Shelly Cloud mobile application.

The User can register and access the Shelly Cloud, using either Android or iOS mobile applications, or any internet browser and the web site: <https://my.Shelly.cloud/>.

Installation Instructions



CAUTION! Danger of electrocution. The mounting/installation of the Device should be done by a qualified person (electrician).



CAUTION! Danger of electrocution. Even when the Device is turned off, it is possible to have voltage across its clamps. Every change in the connection of the clamps has to be done after ensuring all local power is powered off/disconnected.



CAUTION! Do not connect the Device to appliances exceeding the given max load!



CAUTION! Connect the Device only in the way shown in these instructions. Any other method could cause damage and/or injury.



CAUTION! Before beginning the installation please read the accompanying documentation carefully and completely. Failure to follow recommended procedures could lead to malfunction, danger to your life or violation of the law. Allterco Robotics is not responsible for any loss or damage in case of incorrect installation or operation of this Device.



CAUTION! Use the Device only with power grid and appliances which comply with all applicable regulations. short circuit in the power grid or any appliance connected to the Device may damage the Device.



RECOMMENDATION: The Device may be connected to and may control electric circuits and appliances only if they comply with the respective standards and safety norms.



RECOMMENDATION: The Device may be connected with solid single-core cables with increased heat resistance to insulation not less than PVC T105°C.

Initial Inclusion

Connect the Relay to the power grid and install it in the switchboard as shown in the scheme (fig. 1) and following the Safety Instructions. Before installing/mounting the Device ensure that the grid is powered off (turned down breakers) and in compliance with the Safety Norms.

You may choose if you want to use Shelly with the Shelly Cloud mobile application and Shelly Cloud service. You can also familiarize yourself with the instructions for Management and Control through the embedded Web interface.

Control your home with your voice

All Shelly devices are compatible with Amazon Echo and Google Home.

Please see our step-by-step guide on:

<https://shelly.cloud/compatibility/Alexa>

<https://shelly.cloud/compatibility/Assistant>



MOBILE APPLICATION FOR SHELLY®



Allterco Robotics EOOD
Sofia, Bulgaria © March, 2017

The Shelly Cloud Mobile Application

Shelly Cloud gives you opportunity to control and adjust all Shelly® Devices from anywhere in the world.

You only need an Internet connection and our mobile application, installed on your smartphone or tablet.

To install the application please visit Google Play (Android - fig.4) or App Store (iOS - fig.5) and install the Shelly Cloud app.

fig. 4

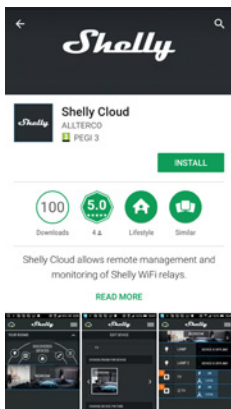

fig. 5



Registration

The first time you open the Shelly Cloud mobile app, you have to create an account which can manage all your Shelly® Devices.

Forgotten Password

In case you forget or lose your password, just enter the e-mail address you have used in your registration. You will then receive instructions on how to change your password.



WARNING! Be careful when you type your e-mail address during the registration, as it will be used in case you forgot your password.

After registering, create your first room (or rooms), where you are going to add and use your Shelly Devices. Shelly Cloud gives you the opportunity to create scenes for

automatic turning on or off of the Devices at predefined hours or based on other parameters like temperature, humidity, light etc.

Shelly Cloud allows easy control and monitoring by using a mobile phone, tablet or PC.

Device Inclusion

To add a new Shelly Device, install it to the power grid following the Installation Instructions included with the Device.

Step 1

Mount the Relay into the switchboard and turn the power on. In a few seconds Shelly will turn on and will create its own WiFi Access Point (AP).



WARNING: In case the Device has not created its own WiFi network with SSID like **shellys4pro-35FA58** check if you have connected Shelly correctly by the schemes described above.

If you don't see active WiFi network with SSID like **shellys4pro-35FA58** restart the Device by one of these methods:

- Push the button next to the display and go to the WiFi settings screen. Press and hold the button for 5 seconds. A timer appears, indicating the countdown to AP mode reset. If not, please repeat or contact our customer support at: support@Shelly.cloud
- Push the button next to the display and go to the Device info screen. Press and hold the button for 5 seconds. A timer appears, indicating the countdown to reset to factory defaults. If not, please repeat or contact our customer support at: support@Shelly.cloud

Step 2

Choose "Add Device".

In order to add more Devices later, use the app Menu at the top right corner of the main screen and click "Add Device". Type the name (SSID) and password for the WiFi network, to which you want to add the Device.



Step 3

If using iOS: you will see the following screen:



Press the Home button of your iPhone/iPad/iPod. Open Settings > WiFi and connect to the WiFi network created by Shelly, e.g. **shellys4pro-35FA58**.

If using Android: your phone/tablet will automatically scan and include all new Shelly Devices found in the WiFi network that you are connected to.



Step 4:

Approximately 30 seconds after discovery of any new Devices on the local WiFi network, a list will be displayed by default in the "Discovered Devices" room.

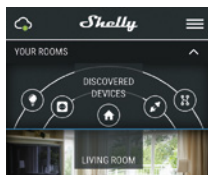

Step 5:

Select the Discovered Devices and choose the Device you want to include in your account.

Upon successful Device Inclusion to the WiFi network you will see the following pop-up:

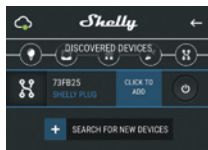
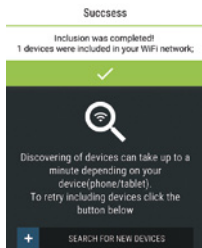

Step 6:

Enter a name for the Device (in the Device name field). Choose a Room, in which the Device has to be positioned. You can choose an icon or add a picture to make it easier to recognize. Press "Save Device".

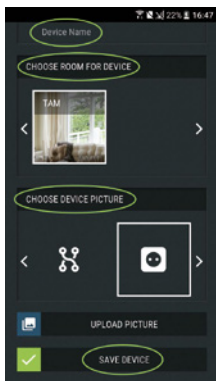

Step 7:

To enable connection to the Shelly Cloud service for remote control and monitoring of the Device, press "YES" on the following pop-up.

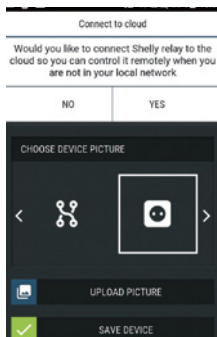

Shelly Devices Settings

After your Shelly Device is included in the app, you can control it, change its settings and automate the way it works.

To switch the Device on and off, use the respective ON/OFF button.

To enter at the details menu of the respective Device, simply click on it's name.

From the details menu you can control the Device, as well as edit its appearance and settings.



EDIT DEVICE – allows you to change the Device's name, room and picture.

DEVICE SETTINGS – allows you to change settings. For example, with Restrict login you may enter a username and password to restrict access to the embedded web interface in the Shelly Device. You can automate the Device operations from this menu as well.

Auto ON/OFF

To manage the power supply automatically, you may use:

When ON – Auto OFF after: After turning on, the power supply will automatically shutdown after a predefined time (in seconds). A value of 0 will cancel the automatic shutdown.

When OFF – After turning off, the power supply will be automatically turned on after a predefined time (in seconds). A value of 0 will cancel the automatic power-on.

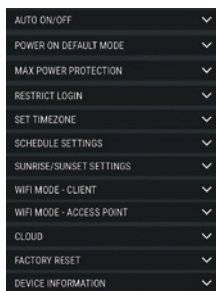

Power On Default Mode

This setting controls whether the Device will supply power or not the output as a default whenever it is receiving power from the grid:

ON: When the Device is powered, by default the socket will be powered.

OFF: Even if the Device is powered, by default the socket will not be powered.

Restore Last Mode: When power is restored, by default, the appliance will return to the last state it was in before the last power off/shutdown.

Max Power Per Channel: You can limit the maximum power the relay will supply on each channel. If the pre-set current draw is exceeded, Shelly will turn the power off. Allowable power can be set up to 2300W.

Button Type:

- **Momentary** - Set Shelly input to be buttons. Push for ON, push again for OFF.
- **Toggle Switch** - Set Shelly input to be flip switches, with one state for ON and another state for OFF.

Schedule Settings



This function requires an Internet connection. To use Internet, a Shelly Device has to be connected to a local WiFi network with working internet connection. Shelly may turn on/off automatically at a predefined time.

Sunrise/Sunset hours



This function requires an Internet connection. To use Internet, a Shelly Device has to be connected to a local WiFi network with a working Internet connection.

Shelly receives actual information through the Internet about the time of sunrise and sunset in your area. Shelly can turn on or off automatically at sunrise/sunset, or at a specified time before or after sunrise/sunset.

Some of the features of the Shelly Cloud mobile application are available at <https://my.Shelly.cloud/> as well.

The Embedded Web Interface

Even without the mobile app the Shelly Device can be set and controlled through a browser and WiFi connection of a mobile phone, tablet or PC.

ABBREVIATIONS USED:

Shelly-ID – the unique name of the Device. It consists of **6** or more characters. It may include numbers and letters, for example **35FA58**.

SSID – the name of the WiFi network, created by the Device, for example **shellys4pro-35FA58**.

Access Point (AP) – the mode in which the Device creates its own WiFi connection point with the respective name (SSID).

Client Mode (CM) – the mode in which the Device is connected to another WiFi network.

Installation/Initial inclusion

Step 1

Connect Shelly to the power grid following the schemes described above and place it into the console. After turning the power on Shelly will create its own WiFi network (AP).



WARNING: In case the Device has not created its own WiFi network with SSID like **shellys4pro-35FA58** check if you have connected Shelly correctly by the schemes described above. If you don't see active WiFi network with SSID like **shellys4pro-35FA58** restart the Device by the ways above.

Step 2

When Shelly has created an own WiFi network (own AP), with name (SSID) such as: **shellys4pro-35FA58**.

Connect to it with your phone, tablet or PC.

Step 3

Type **192.168.33.1** into the address field of your browser to load the web interface of the Shelly Device.

General - Home Page

This is the home page of the embedded web interface. If it has been set up is correctly, you will see information about:

- Current electrical consumption
- Settings menu button
- Current state (on/off)
- Present time

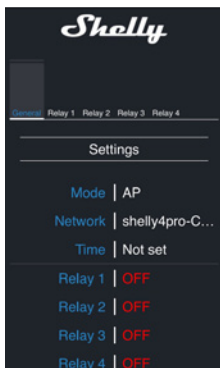

Settings – General Settings

In this menu, you can configure the Shelly Device's work and connection modes.

WiFi Settings – the WiFi connection settings.

Access Point (AP) Mode: allows the Device to operate as a WiFi access point. the User can change the name (SSID) and the password to access the WiFi. After you have entered the desired settings, press Connect.

WiFi Client Mode (CM): allows the Device to connect to an available WiFi network. in order to switch to this mode, the User must enter the name (SSID) and the password to connect to a local WiFi network. After entering the correct details, press Connect.



ATTENTION! If you have entered incorrect information (wrong settings, usernames, passwords etc.), you will not be able to connect to Shelly. Please restart the Device by using the above description.



WARNING: Reset of the Device by one of these methods:

- Push the button next to the display and go to the WiFi settings screen. Press and hold the button for 5 seconds. A timer appears, indicating the countdown to AP mode reset. If not, please repeat or contact our customer support at: support@Shelly.cloud

- Push the button next to the display and go to the Device info screen. Press and hold the button for 5 seconds. A timer appears, indicating the countdown to reset to factory defaults. If not, please repeat or contact our customer support at: support@Shelly.cloud

Login: Access to the Device

Leave Unprotected - removing the notification for disabled authorization.

Set Login – you can turn authentication on or off

Username - A username set by you

Password - A password set by you

This is where you can change your username and password. You must enter a new username and the new password, then press Save to save the changes.

Connect to Cloud: You can turn the connection between Shelly and Shelly Cloud on or off.

Factory reset: Return Shelly to its factory settings.

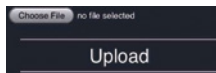

Firmware Upgrade: Shows present firmware version. If a newer version is available, officially announced and published by the Manufacturer, you can update your Shelly Device. Click Choose File you to choose the previously downloaded firmware update file. Then click the Upload File to install it to your Shelly Device.

Device Reboot: Reboots the Device.

Relay 1/Relay 2/Relay 3/ Relay 4 Screen

In this screen you can control, monitor and change the settings for turning the power on and off. You can also see the current status of the connected appliance (electrical load/ power consumption) to Shelly, Buttons Settings, On and Off.

To control Shelly press Relay1/Relay 2/Relay 3/Relay 4:



To turn on the connected circuit press "Turn ON".

To turn off the connected circuit press "Turn OFF"

Press the icon ➤ to go to the previous menu.

Shelly Management Settings

Each Shelly Device can be configured individually. This lets you personalize each Shelly Device in a unique manner, or consistently, as you choose.

Power On Default Mode

This sets the relays' default state when powered from the power grid.

ON: By default when the socket is powered and the connected circuit/appliance to it will be powered as well.

OFF: By default the socket and any connected circuit/appliance will not be powered, even when it is connected to the grid.

Restore Last State: By default the relay and the connected circuit/appliance will be returned to the last state they occupied (on or off) before the last power off/shutdown.

SWITCH: By default the Relay will operate accordingly to the state of the switch/button connected to Shelly.

Auto ON/OFF

Automatic powering/shutdown of the socket and the connected appliance:

When ON – Auto OFF after: After turning on, the power supply will be automatically shut down after a predefined time (in seconds). A value of 0 will cancel the automatic shutdown.

When OFF – Auto ON after: After turning off, the power supply will be automatically turned on after a predefined time (in seconds). A value of 0 will cancel the automatic start.

Button Type

- **Momentary:** When using a button.
- **Toggle Switch:** When using a switch.
- **Edge Switch:** Shelly will change its state on every push

Sunrise/Sunset hours



This function requires an Internet connection. To use Internet, a Shelly Device has to be connected to a local WiFi network with a working Internet connection.

Shelly receives actual information through the Internet about the time of sunrise and sunset in your area. Shelly may turn on or off automatically at sunrise/sunset, or at a specified time before or after sunrise/sunset.

On/Off hours



This function requires an Internet connection. To use Internet, a Shelly Device has to be connected to a local WiFi network with working internet connection.

Shelly may turn on/off automatically at a predefined time.

Additional Features

Shelly allows control via HTTP from any other Device, home automation controller, mobile app or server.

For more information about the REST control protocol, please visit:

www.Shelly.cloud or send a request to developers@Shelly.cloud.

Warranty Terms

1. The Device's warranty term is 24 (twenty four) months, beginning with the date of purchase by the End User. The Manufacturer is not responsible for extra warranty terms by any other than the Manufacturer.

2. The Warranty is valid for the territory of EU.

The warranty is applicable in compliance with all relevant laws and users' rights protections. The purchaser of the Device is entitled to exercise his/her rights in accordance with all applicable laws and regulations.

3. Warranty terms are provided by Allterco Robotics EOOD (referred hereinafter as the Manufacturer), incorporated under the Bulgarian law, with address of registration 109 Bulgaria Blvd, floor 8, Triaditsa Region, Sofia 1404, Bulgaria, registered with the Commercial Register kept by the Bulgarian Ministry of Justice's Registry Agency under Unified Identity Code (UIC) 202320104.

4. Claims regarding the Conformity of the Device with the terms of the contract of sale shall be addressed to the Seller, in accordance with its terms of sale.

5. Damages such as death or body injury, deterioration or damages to objects different from the defective product, caused by a defective product, are to be claimed against the Manufacturer using the contact data of the Manufacturer's company.

6. The User may contact the Manufacturer via e-mail at support@Shelly.cloud for operational problems that may be resolved remotely. It is recommended that the User contact the Manufacturer before sending the Device for servicing.

7. The terms of removing defects depends on the commercial terms of the Seller.

The Manufacturer is not responsible for untimely servicing of the Device or for faulty repairs carried out by unauthorized service.

8. When exercising their rights under this warranty, the User must provide the Device with the following documents: receipt and valid warranty card with date of purchase.

9. After a warranty repair has been carried out, the warranty period is extended only for that period.

10. The warranty does NOT cover any damages to the Device which occur in the following circumstances:

When the Device has been used or wired inappropriately, including inappropriate fuses, overpassing maximal values of load and current, electric shock, short circuit or other problems in the power supply, the power grid or the radio network.

When there is a non-compliance between warranty card and/or without a purchase receipt, or attempted forgery of these documents, including (but not limited to) the warranty card or the documents proving the purchase.

When there has been a self-repair attempt, (de)installation, modification, or adaptation of the Device by unauthorized persons.

Intentional or negligent improper handling, storing or transportation of the Device, or in the event of non-observance of the instructions included in this warranty.

When a non-standard power supply, network, or faulty Devices have been used.

When damages occur which were caused regardless of the Manufacturer, including but not limited to: floods, storms, fire, lightning, natural disasters, earthquakes, war, civil wars, other force majeure, unforeseen accidents, robbery, water damage, any damages made by ingress of liquids, weather conditions, solar heating, any damages made by intrusion of sand, humidity, high or low temperature, or air pollution.

When there are other reasons beyond manufacturing defect, including but not limited to: water damage, ingress of liquid into the Device, weather conditions, solar overheating, intrusion of sand, humidity, low or high temperature, air pollution.[u1]

When there have been mechanical damages (forced opening, breaking, cracks, scratches or deformations) caused by a hit, fall, or from another object, wrong use, or caused by not following the instructions for use.

When damage has been caused by exposing the Device to severe outdoor conditions such as: high humidity, dust, too low or too high temperature. Terms of proper storage are specified in the User Manual.

When damage has been caused by lack of maintenance by the User, as specified in the User manual.

When damage has been caused by faulty accessories, or those not recommended by the Manufacturer.

When damage has been caused by the use of non-original spare parts or accessories not suitable for the specified Device model, or after repairs and changes carried out by an unauthorized service or person.

When damage has been caused by the use of faulty Devices and/or accessories.

When damage has been caused by faulty software, a computer virus or other harmful behaviour on the Internet, or by lack of software updates or incorrect updates by a method not provided by either the Manufacturer or by the Manufacturer's software.

11. The range of warranty repairs does not include periodical maintenance and inspections, particularly cleaning, adjustments, checks, bug fixes or program parameters and other activities that must be performed by the User (Buyer). The warranty does not cover wear of the Device, because such elements have a limited lifespan.

12. The Manufacturer is not responsible for any property damage caused by a defect in the Device. The Manufacturer is not liable for indirect damages (including but not limited to loss of profits, savings, lost profits, claims by third parties) in connection with any defect of the Device, nor for any property damage or personal injury arising out of or related to the use of the Device.

13. The Manufacturer is not responsible for damage caused by circumstances independent of the Manufacturer, including but not limited to: floods, storms, fire, lightning, natural disasters, earthquakes, war, civil unrest and other force majeure, unforeseen accidents, or theft.

Warranty Card

Shelly® Quad Relay Switch (model S4Pro-1.0)

.....
Serial number:

.....
Date of purchase:

.....
Signature of Merchant (Seller):

Please save this part of the Warranty card. For carrying out the rights under the current warranty, you need to provide an original invoice and/or receipt, proving your purchase was valid.

Manufacturer: Allterco Robotics EOOD
Address: Sofia, 1407, 103 Cherni vrah Blvd.
Tel.: +359 2 988 7435
E-mail: support@Shelly.cloud
<http://www.Shelly.cloud>

2019/01/v05

The Declaration of Conformity is available at:
<https://Shelly.cloud/declaration-of-conformity/>

Changes in the contact data are published by the Manufacturer at the official website of the Device: <http://www.Shelly.cloud>

The User is obliged to stay informed for any amendments of these warranty terms before exercising his/her rights against the Manufacturer.

All rights to trademarks She® and Shelly®, and other intellectual rights associated with this Device belong to Allterco Robotics EOOD.

